

GM-69-3000

- Aluminium housing
- Weather proof
- BS 5839

The 3 × 50 Watt loudspeaker is equipped with 3 × 8 full range loudspeaker chassis à 77 mm and a 100 V transformer with four power adjustments.

The powder coated and shock-resistant aluminium housing in RAL 9006 guarantees long-term stability. For additional reliability, a 2 pin-ceramic block, a thermal fuse is provided and the speaker chassis is impregnated against wetness. Furthermore sturdy cable glands 2 × PG9 are also provided.

The speaker is also secured with the high protection class IP 66 against the security risks of environmental influences. The speaker is compliant with the British Standard BS 5839, Part 8.

The easy mounting with the included swivel bracket provides much flexibility for the installation.

Special paint of the speaker in 4-digit RAL- or NCS- colour available at extra cost.

Technical datas

Electric

Power	3 × 50/30/15/7.5 W
Impedance (100 V)	200/333/667/1333 Ω
Frequency response	110–18'000 Hz
SPL 1 W/1 m	102.8 dB
SPL 1 W/4 m	90.8 dB
SPL Pmax/4 m	105.0 dB
SPL Pmax/8 m	102.0 dB
SPL Pmax/16 m	98.0 dB
SPL Pmax/32 m	92.0 dB
Sensitivity EN 54-24, 1 W/4 m	82.7 dB
Sensitivity IEC 268-5, 1 W/1 m	94.7 dB
Dispersion -6 dB, 500 Hz	H: 360°, V: 16°
Dispersion -6 dB, 1 KHz	H: 142°, V: 10°
Dispersion -6 dB, 2 KHz	H: 122°, V: 6°
Dispersion -6 dB, 4 KHz	H: 82°, V: 5°

Mechanic

Dimensions (W × H × D)	100 × 2913 × 92 mm
Weight	15.3 kg
Material	Aluminium
Temperature range	-20°C to +90°C
Standard color	RAL 9006
Special colors	RAL or NCS
Mounting	Brackets
Connector	2-pin ceramic block
Maximum cable cross section	8 mm ²
Max. cable cross section loop	2 × 2 mm ²
Protection	IP66



Polar plot

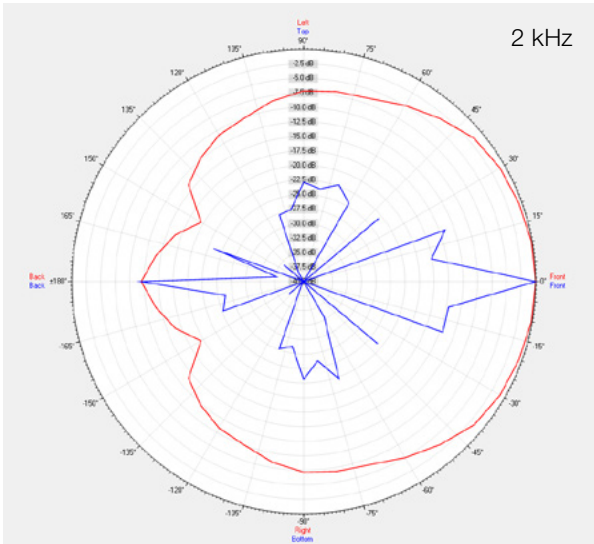

Frequency response

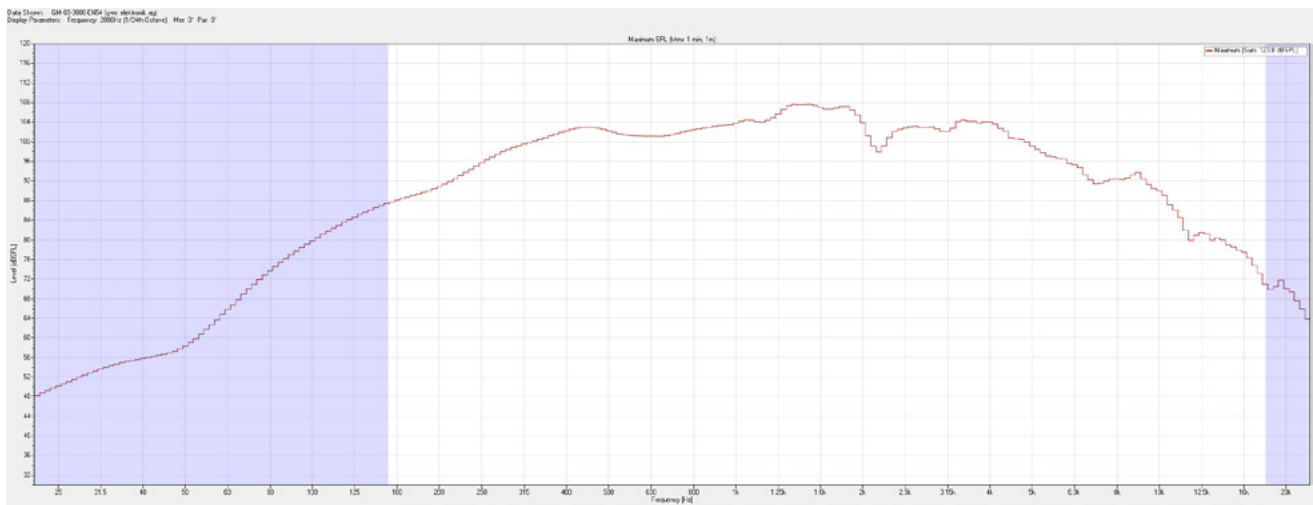

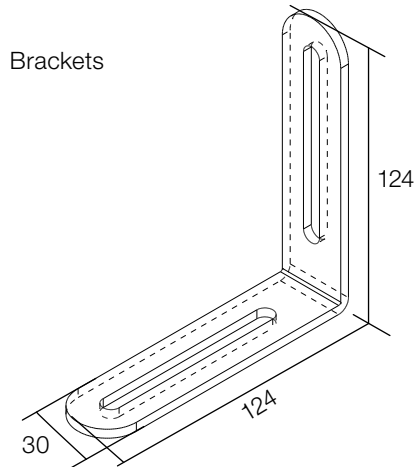
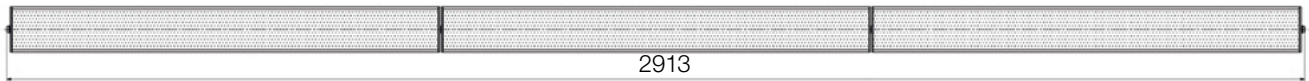
Dimensions (in mm)**Information**

Loudspeakers from g+m elektronik ag are tested and classified according to the IEC standard 60529 (degree of protection by enclosure) against the penetration of foreign objects and moisture. The classification is conforming to standards through characterization with a fixed code. This code consists of the letters IP (International Protection) followed by two digits. The first digit indicates the degree of protection against dust and the second digit the degree of protection against water. Please note that the testing of the products has been carried out in laboratory conditions which are not always 100% comparable with the conditions of different installation environments. This protection can be reduced due to normal wear and tear depending on the installation environment. Therefore our warranty does not cover any damage caused by liquids.

Measurements according to DIN IEC 268-5 | RoHS compliant (2011/65/EU).