

Shadow-142L

Line Array, Weatherproof

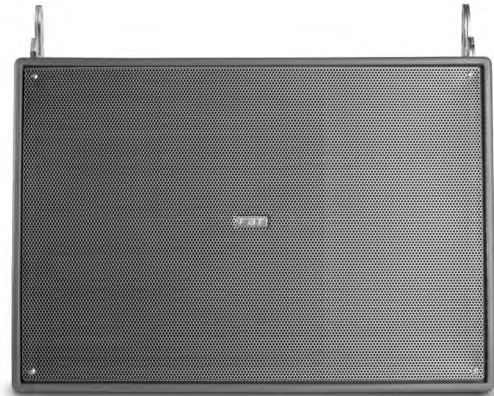

Features

- All-weather loudspeaker
- Protection against humidity due to robust construction with maximum sound pressure
- High-quality music and speech reproduction for indoor and outdoor use
- Especially suitable for sports fields, swimming pools, theme parks, restaurants etc.

Specifications

Loudspeaker system	2-way
Nominal noise power 8 Ω	500 W
Sensitivity (1 W/1 m)	LF 98 dB / HF 110 dB
Maximum SPL	126.5 dB / 137 dB
Frequency range (-6 dB)	60–20'000 Hz
Coverage angle	100°H x 15°V
Dimensions (W x H x D)	615 x 430 x 415 mm
Connenction	Cable
Cabinet material	Plastic
Weight	38 kg
Color	Grey RAL 7011
Protection	IP55

Ordering information

Shadow-142L	Loudspeaker, weatherproof, Line array
SW-F 142	Flying bar

Electrical connection



SHADOW

FBT

142L ALL WEATHER LOUDSPEAKERS

Connections: 1 - IN + 2 - IN - 3 - nc 4 - nc	Recommended Amplifier: 1000W System Long Term Power: 500W Dispersion: 100° x 15° Frequency Response: 60Hz-20kHz Nominal Impedance: 8 Ohm
---	---

MADE IN ITALY

Dimensions in mm

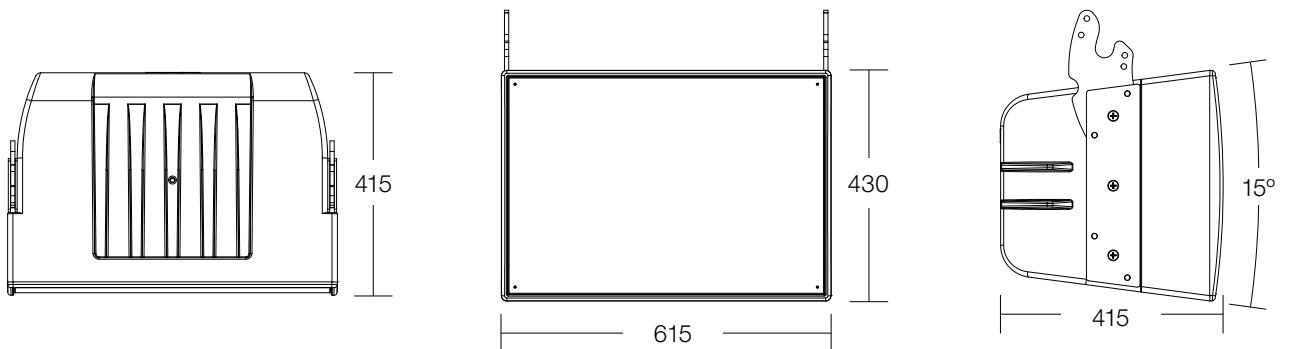

Flying bar SW-F142

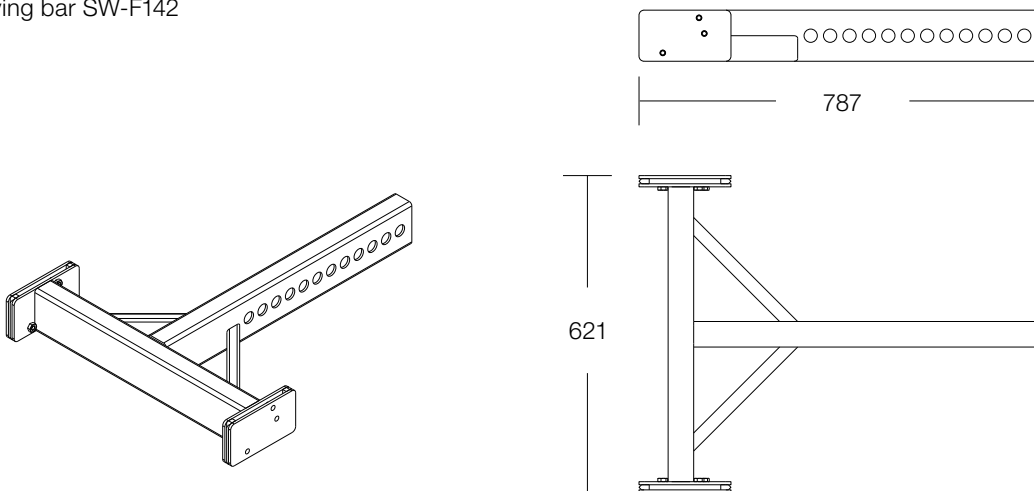

Frequency response | Polar plot

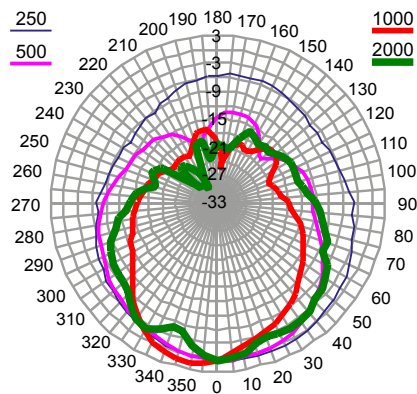
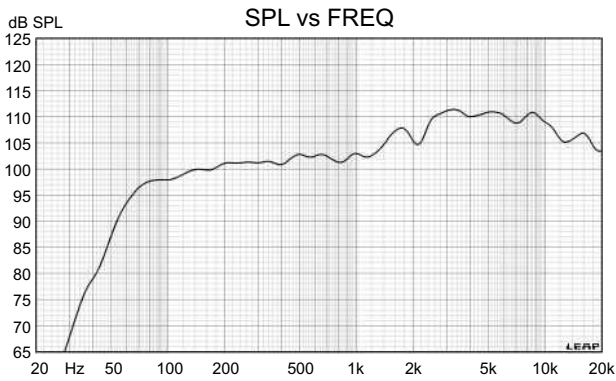

Horizontal

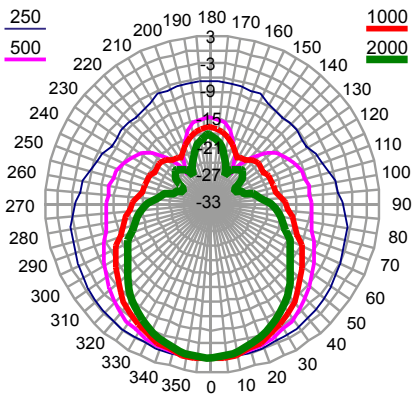
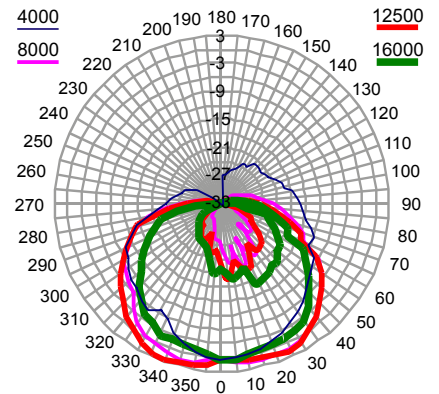

Vertical

